



**Model G12**



Model #: \_\_\_\_\_

Serial #: \_\_\_\_\_



Intertek



Intertek

## **Instruction Manual for the Globe Slicer Models: G10, G12, G12A, and G14**

### **For Service on Your Slicer:**

1. Visit our website at [www.globefoodequip.com](http://www.globefoodequip.com)
2. Or call the Globe Service Department at 937-299-8625 and ask for contact information for your local service company.

Visit our website for information on additional products available from Globe.

**[www.globefoodequip.com](http://www.globefoodequip.com)**

***Slicers, Mixers, Countertop Cooking Equipment, Meat Choppers & Scales***

### **- IMPORTANT SAFETY NOTICE -**

This manual contains important safety instructions that must be strictly followed when using this equipment.

WARRANTY REGISTRATION  
SCAN THE QR CODE WITH YOUR MOBILE DEVICE OR GO TO  
[WWW.GLOBEFOODEQUIP.COM](http://WWW.GLOBEFOODEQUIP.COM)  
TO FILL OUT AND SUBMIT YOUR WARRANTY REGISTRATION.

[WWW.GLOBEFOODEQUIP.COM/SUPPORT/WARRANTY-REGISTRATION-FORM](http://WWW.GLOBEFOODEQUIP.COM/SUPPORT/WARRANTY-REGISTRATION-FORM)

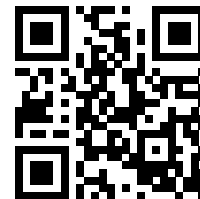

# Index

ATTENTION OWNERS AND OPERATORS.....	3
KEY COMPONENTS OF THE SLICER .....	4
GLOBE SLICER SAFETY TIPS .....	5
INSTALLATION .....	6-7
OPERATING INSTRUCTIONS.....	8-9
CLEANING & SANITIZING.....	10-13
KNIFE SHARPENING .....	14-15
SIMPLE MAINTENANCE AND REPAIR.....	16-17
TROUBLESHOOTING GUIDE .....	18
LIMITED SLICER WARRANTY .....	20



**GLOBE FOOD EQUIPMENT CO.**  
**2153 DRYDEN RD.**  
**DAYTON, OH 45439**  
**Toll Free: 800-347-5423**  
**PHONE: 937-299-5493**  
**FAX: 937-299-8623**  
**E-MAIL: [info@globefoodequip.com](mailto:info@globefoodequip.com)**  
**WEBSITE: [www.globefoodequip.com](http://www.globefoodequip.com)**

# Attention Owners and Operators

Globe's equipment is designed to provide years of safe and productive processing of food products as long as the equipment is used in accordance with the instructions in this manual and is properly maintained. Importantly, unless the operator is adequately trained and supervised, there is a possibility of serious injury. Owners of this equipment bear the responsibility to make certain that this equipment is used properly and safely. Strictly follow all of the instructions contained in this manual and the requirements of local, state and federal law.

Owners should not permit anyone to touch this equipment unless they are over 18 years of age, are adequately trained and supervised, and have read and understand this manual. Owners should also ensure that no customers, visitors or other unauthorized personnel come in contact with this equipment. Please remember that Globe cannot anticipate every circumstance or environment in which its equipment will be operated. It is the responsibility of the owner and the operator to remain alert to any hazards posed by the function of this equipment, particularly the sharp knife blade and all moving parts. If you are ever uncertain about a particular task or the proper method of operating this equipment, ask your supervisor.

To prevent illness caused by the spread of food-borne pathogens, it is important to properly clean and sanitize the entire slicer as any surface of the slicer can become contaminated. It is the responsibility of the slicer owner/operator to follow all guidelines, instructions and laws as established by your local and state health departments and the manufacturers of chemical sanitizers.

When cleaning your slicer, pay particular attention to cracks, broken seams and any area that may collect food debris. If your slicer, or any of its parts, is damaged or broken, it may become more difficult to properly clean and sanitize the unit. If your slicer is damaged or needs repair, contact an experienced service individual immediately to ensure the slicer can be properly sanitized. If you have any questions, please contact Globe at 937-299-5493.

This manual offers information to supplement your procedures to improve the sanitization of your machine and contains a Safety Tips section listing a number of precautions to follow to help promote safe use of this equipment. Throughout the manual you will see additional warnings to help alert you to potential hazards.

**Warnings affecting your personal safety are indicated by:**



**Warnings related to possible damage to the equipment are indicated by:**



A wall chart with safety instructions is included with this equipment. This wall chart should be posted near the slicer within easy view of the operator. You should make certain that this manual is available for easy reference by any operator. Globe has put several warning labels in the English language on the slicer. French and Spanish labels are also available and can replace the English labels at the owner's discretion. If the warning labels, the wall chart, or this manual are misplaced, damaged or illegible, or if you require additional copies, please contact your nearest representative or Globe directly for these items at no charge.

Please remember that this manual, the wall chart and the warning labels do not replace the need to be alert, to properly train and supervise operators, and to use common sense when using this equipment.

# Key Components of the Slicer

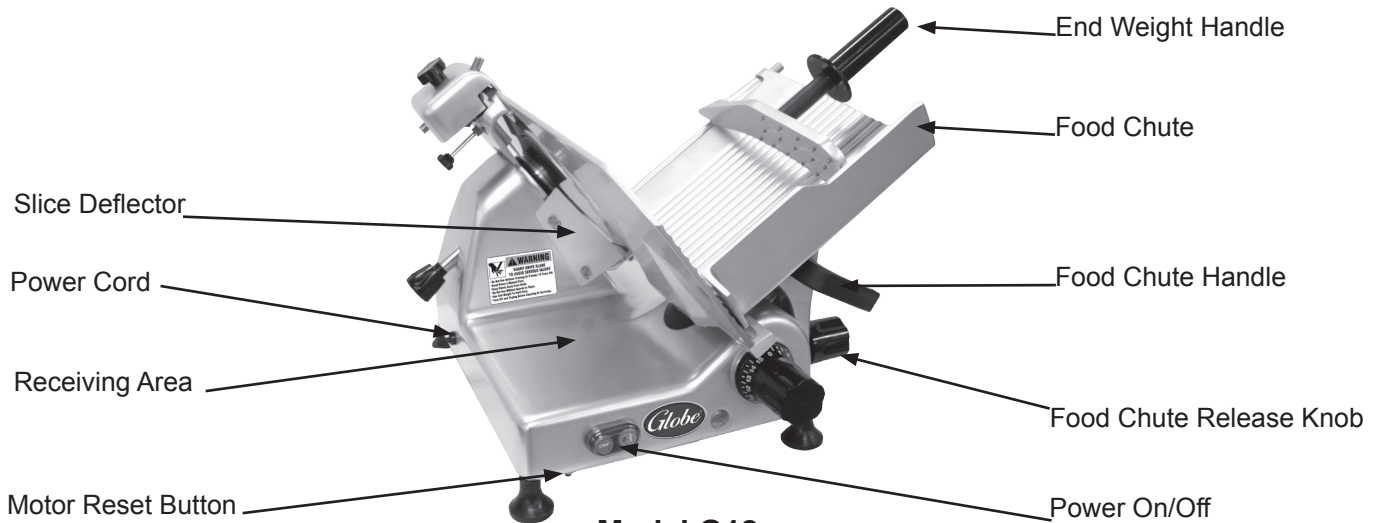

**Model G12**

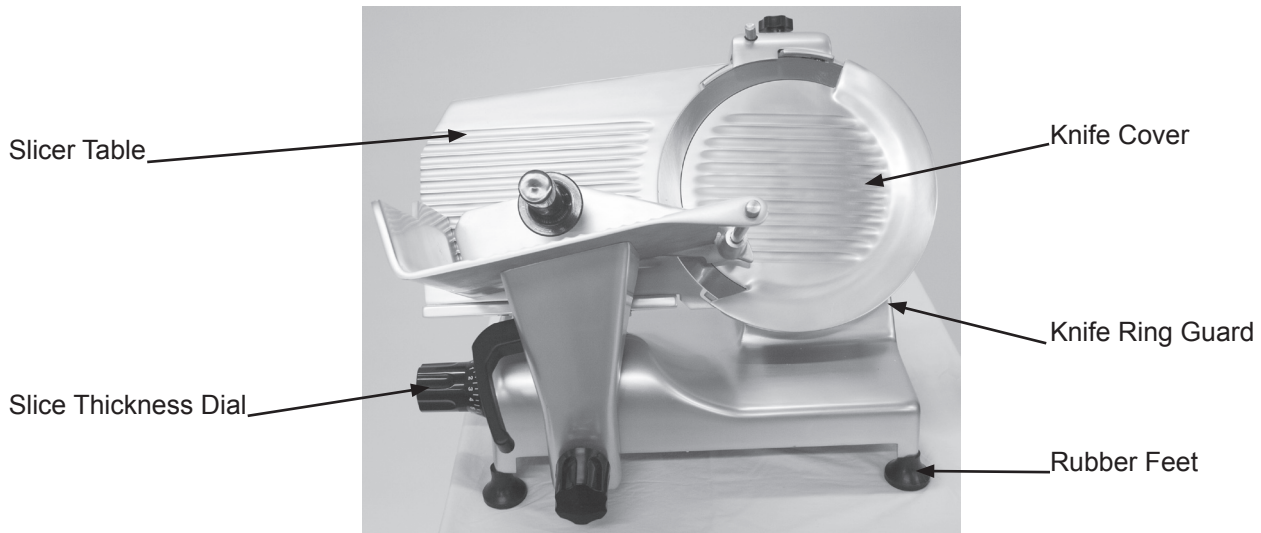

**Model G12**



**Model G12A**

## Globe Slicer Safety Tips

# **WARNING**



## SHARP KNIFE BLADE

### TO AVOID SERIOUS PERSONAL INJURY:

- **NEVER** touch this slicer without training and authorization from your supervisor or if you are under 18 years old. Read this instruction manual first.
- **ONLY** install the slicer on a level nonskid surface that is nonflammable and is located in a clean, well-lit work area away from children and visitors.
- **ALWAYS** ground slicer utilizing proper power source.
- **NEVER TOUCH KNIFE.** Keep hands and arms away from all moving parts.
- **NEVER OPERATE** slicer without knife cover, knife sharpener and knife ring guard securely installed.
- **BEFORE TURNING SLICER ON,** place auto engage lever in “Manual” position (G12A only).
- **BE ALERT.** The food chute moves back and forth during automatic operation and can move in either direction on start up (G12A only).
- **NEVER HOLD THE FOOD PRODUCT WHILE SLICING.** Hold only the end weight handle to slice.
- **DO NOT CATCH SLICES WITH YOUR HAND.** Let slices drop onto the receiving area.
- **ALWAYS** turn slicer off, return auto engage lever to “Manual” position (G12A only) and turn the slice thickness dial clockwise until it stops after each use.
- **BEFORE CLEANING, SHARPENING, SERVICING, OR REMOVING ANY PARTS** always turn slicer off, turn the slice thickness dial clockwise until it stops, remove food chute and unplug power cord.
- **ALWAYS** properly clean and sanitize your slicer. To prevent illness or death caused by the spread of food-borne pathogens, it is important to properly clean and sanitize the entire slicer as any surface of the slicer can become contaminated. It is the responsibility of the slicer owner/operator to follow all guidelines, instructions and laws as established by your local and state health departments and the manufacturers of chemical sanitizers.
- **USE ONLY GLOBE SLICER ACCESSORIES** properly installed.

# Installation

## UNPACKING

1. Unpack the slicer immediately after receipt. If the machine is found to be damaged, save the packaging material and contact the carrier within fifteen (15) days of delivery and immediately contact your source of the equipment. **You have no recourse for damage after fifteen (15) days of receipt.**
2. With the slicer you should receive: four rubber feet, lubricating oil and an instruction manual. Contact Globe or your local supplier if you did not receive all of these items.



## **TO AVOID SERIOUS PERSONAL INJURY PROPERLY INSTALL SLICER IN ADEQUATE WORK AREA**

- **ALWAYS** install equipment in a work area with adequate light and space.
- **ONLY** operate on a solid, level, nonskid surface that is nonflammable.
- **NEVER** operate slicer with a damaged power cord or power plug.
- **NEVER** operate slicer with an extension cord.
- **NEVER** bypass, alter, or modify this equipment in any way from its original condition. Doing so can create hazards and will void warranty.
- **NEVER** operate slicer without the knife cover, knife sharpener and knife ring guard securely installed.
- **NEVER** operate slicer without the warning labels attached to slicer (see page 4 for location) and the Globe wall chart posted within view of operator.

## INSTALLATION:

1. Read this manual thoroughly before installation and operation. **DO NOT** proceed with installation and operation if you have any questions or if you do not understand anything in the manual. Contact your local representative or Globe first. **Make sure to clean and sanitize your entire slicer before use. Refer to this manual for cleaning and sanitizing guidelines.**

2. Remove slicer from the corrugated box.
3. Make sure rubber feet are firmly tightened.
4. Loosen the food chute release knob that fastens the food chute arm to the slicer base (Fig. 6-1).

NOTE: To protect the food chute during shipping, the food chute is packaged uninstalled. The food chute must be installed on the food chute arm.

5. Remove the food chute arm from the slicer base.

NOTE: The food chute release knob is not designed to come completely off.

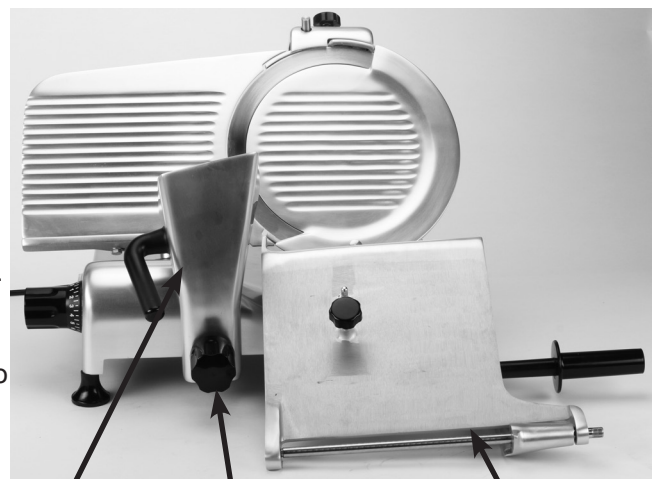

Food Chute Arm      Food Chute Release Knob      Food Chute

Figure 6-1

# Installation

6. Install food chute on food chute arm (Fig. 7-1).
7. Install food chute arm and food chute on slicer base. Securely tighten food chute release knob to prevent “play” between food chute and chute arm (Fig. 7-2).



**NEVER USE SLICER WITHOUT RUBBER FEET ON UNIT.**

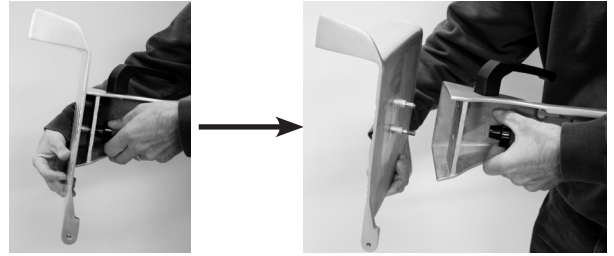

Figure 7-1

8. Select a location for the slicer that has a level, solid, nonskid surface that is nonflammable and is in a well-lit work area that is away from children and visitors.



**USE AT LEAST TWO PEOPLE TO LIFT SLICER UP TO OPERATING LOCATION. NEVER ATTEMPT TO LIFT SLICER ALONE.**



**THIS MACHINE IS PROVIDED WITH A THREE-PRONG GROUNDING PLUG. THE OUTLET TO WHICH THIS PLUG IS CONNECTED MUST BE PROPERLY GROUNDED. IF THE RECEPTACLE IS NOT THE PROPER GROUNDING TYPE, CONTACT AN ELECTRICIAN. DO NOT, UNDER ANY CIRCUMSTANCES, CUT OR REMOVE THE THIRD GROUND PRONG FROM THE POWER CORD OR USE ANY ADAPTER PLUG (Fig. 7-3 and Fig. 7-4).**



Figure 7-2

9. Inspect slicer to make sure all parts have been provided.
10. Make sure knife cover, knife ring guard and knife sharpener are in place.
11. Make sure warning label is properly positioned and legible and the instruction manual is available near slicer.
12. Complete warranty registration online at [www.globefoodequip.com/support/warranty-registration-form](http://www.globefoodequip.com/support/warranty-registration-form).
13. Post the provided wall chart in a visible area near slicer. Refer to this wall chart and the Owner's Manual for proper cleaning, sanitizing and inspection of your slicer.
14. Clean slicer using the procedures outlined in Cleaning & Sanitizing (pages 10 and 13) before using slicer.
15. Contact your local representative, or Globe directly, if you have questions or problems with the installation or operation of slicer.



Figure 7-3 Correct



Figure 7-4 Incorrect

# Operating Instructions

**WARNING**



## SHARP KNIFE BLADE

### TO AVOID SERIOUS PERSONAL INJURY:

- **NEVER** touch slicer without training and authorization from your supervisor or if you are under 18 years old. Read this instruction manual first.
- **ONLY** install slicer on a level nonskid surface that is nonflammable and is located in a clean, well-lit work area away from children and visitors.
- **ALWAYS** ground slicer utilizing proper power source.
- **NEVER TOUCH KNIFE.** Keep hands and arms away from all moving parts.
- **NEVER OPERATE** slicer without knife cover, knife sharpener and knife ring guard securely installed.
- **BEFORE TURNING SLICER ON** place auto engage lever in “Manual” position (G12A only).
- **BE ALERT.** Food chute moves back and forth during automatic operation and can move in either direction on start up (G12A only).
- **NEVER HOLD FOOD PRODUCT WHILE SLICING.** Hold only the end weight handle to slice.
- **DO NOT CATCH SLICES WITH YOUR HAND.** Let slices drop onto the receiving area.
- **ALWAYS** turn slicer off, return auto engage lever to “Manual” position (G12A only) and turn slice thickness dial clockwise until it stops after each use.
- **BEFORE CLEANING, SHARPENING, SERVICING, OR REMOVING ANY PARTS** always turn slicer off, turn slice thickness dial clockwise until it stops, remove food chute and unplug power cord.

### MANUAL SLICER OPERATION

1. Make sure all knobs are tightened before using slicer.
2. With slicer turned off, pull food chute completely towards you and place food product onto food chute. When using the G12A as a manual slicer, make sure to push down or lower auto engage lever to the “Manual” position and keep it in that position at all times. Slice only boneless, unfrozen product with slicer. Use end weight to hold food product in place.
3. Rotate slice thickness dial counterclockwise to the desired setting. After slicing is complete, always turn slice thickness dial clockwise until it stops to close slicer table.
4. Turn slicer on by pushing start button. Power indicator light, located near power on button, will illuminate.



# Operating Instructions

**!** **DO NOT hold the food product with your hand. Never put your hand on or around food chute when slicer is on. The food chute handle is the only part of the slicer you should touch while slicing.**

5. Use food chute handle to manually push food chute back and forth. Food chute handle is the only part of slicer you should touch while slicing. Do not catch slices with your hand. Let slices drop onto receiving area.

**!** **If a product needs to be adjusted during slicing, ALWAYS pull the food chute all the way towards you. Turn off slicer, and close slicer table prior to adjusting the product and the end weight.**

6. After the last slice stroke, pull food chute all the way towards you. Turn slicer off by pushing stop button. Power indicator light will go out. Always turn slice thickness dial clockwise until it stops to close slicer table.

7. Now you can unload and load food product from food chute.

## **AUTOMATIC SLICER OPERATION (G12A only)**

1. Make sure slicer is turned off (power indicator light not illuminated). Make sure auto engage lever is in "Manual" position (Fig. 9-1) and food chute moves freely.

2. Pull food chute completely towards you and place food product onto food chute. Slice only boneless, unfrozen product with slicer. Swing end weight into position to secure food product.

3. Rotate slice thickness dial counterclockwise to the desired setting. After slicing is complete, always turn slice thickness dial clockwise until it stops to close slicer table.

4. Press start button. Power indicator light will illuminate (see page 4 for location).

**!** **BE ALERT. The next step will cause food chute to move automatically and it can move either direction on start up.**

**!** **NEVER attempt to adjust, load or unload food chute when slicer is in automatic operation.**

**!** **NEVER put hand into chute arm opening on the right side of slicer.**

5. To make food chute move automatically, pull up or raise auto engage lever into "Automatic" position (Fig. 9-2).

6. To stop the automatic movement of food chute, push down or lower auto engage lever to "Manual" position.

**!** **The knife is still rotating even though the chute has stopped.**

7. To turn slicer completely off and stop knife, press stop button. If auto engage lever has not already been returned to "Manual" position, push down or lower lever to "Manual" position.



Figure 9-1



Figure 9-2

# Cleaning & Sanitizing

## ⚠️ WARNING



## SHARP KNIFE BLADE

TO AVOID SERIOUS PERSONAL INJURY TO THE SLICER OPERATOR AND CUSTOMERS:

- **BEFORE CLEANING, SHARPENING, SERVICING OR REMOVING ANY PARTS** always turn slicer off, turn slice thickness dial clockwise until it stops and unplug power cord.
- **NEVER** attempt to clean slicer with knife running.
- **NEVER** attempt to remove knife or knife ring guard from slicer. They must remain on slicer for proper operation, sharpening, and cleaning.

## ⚠️ WARNING

To prevent illness or death caused by the spread of food-borne pathogens, it is important to properly clean and sanitize the entire slicer as any surface of the slicer can become contaminated. It is the responsibility of the slicer owner/operator to follow all guidelines, instructions and laws as established by your local and state health departments and the manufacturers of chemical sanitizers.



Once your slicer makes contact with food product, the entire slicer, including removable parts, must be thoroughly cleaned and sanitized. This process is to be repeated at least every 4 hours using these procedures and information; and must comply with additional laws from your state and local health departments.



As with all food contact surfaces, it is extremely important to properly sanitize the entire slicer and to **closely follow the instructions on your quaternary sanitizer container to ensure proper sanitation is achieved to kill potentially harmful bacteria.**

**NOTE:** It may be desirable to wear non-cutting safety gloves during the cleaning operation.

**IMPORTANT:** If a chemical sanitizer other than chlorine, iodine or quaternary ammonium is used, it shall be applied in accordance with the EPA-registered label use instructions. Excessive amounts of sanitizer and use of products not formulated for stainless steel or aluminum may VOID your warranty.

Sanitizer concentration shall comply with section 4-501.114, Manual and Mechanical Warewashing Equipment, Chemical Sanitization - Temperature, pH, Concentration, and Hardness of the FDA Food Code.

For more information on proper kitchen and equipment sanitation, visit [www.servsafe.com](http://www.servsafe.com) provided by the National Restaurant Association (NRA).

## ⚠️ CAUTION

- **DO NOT** hose down, pressure wash or pour water on slicer.
- **NEVER** use a scrubber pad, steel wool or abrasive material to clean slicer.
- **NEVER** try to clean, sharpen or operate slicer with lift lever in the raised position (automatic slicers only).
- **ALWAYS** turn slicer OFF and unplug power cord BEFORE cleaning.
- It is extremely important to follow the instructions on the sanitizer container to make sure proper sanitation is achieved. Allow the parts to air dry before placing them back on slicer!

**DO NOT** use bleach, products containing sodium hypochlorite or other caustic/strong detergents on slicer base or removable parts. These products will discolor and destroy the parts.

Slicer components are easily disassembled without the use of special tools. It may be desirable to wear non-cutting safety gloves during the cleaning operation.

# Cleaning & Sanitizing

## DISASSEMBLY & CLEANING

1. Turn slicer off.
2. Turn slice thickness dial clockwise past zero (0) until it stops so table covers knife edge.
3. Unplug power cord.
4. Remove food chute's end weight. Hold end weight and unscrew slide rod (Fig. 11-1). Pull slide rod out of pivot of end weight.
5. Continue by removing the food chute, loosening the food chute release knob that fastens the food chute to the chute arm (Fig. 11-2). **Note: The chute release knob is not designed to come completely off.**

Lift food chute off chute arm.

6. Disassemble food chute. Using knob on back of chute, unscrew food chute into three separate pieces (see photos below).

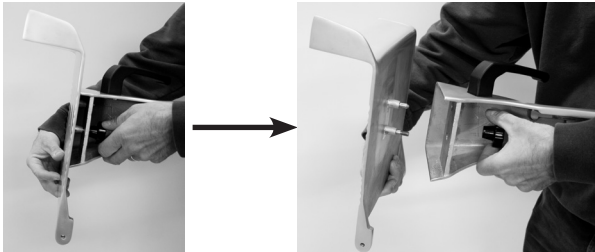

Figure 11-1



Figure 11-2



**BE ALERT.** The next step will expose knife.

7. Remove knife sharpener. Loosen screw on neck of sharpener, then lift knife sharpener off and away from slicer (Fig. 11-3).
8. Remove knife cover by rotating knife cover release knob counterclockwise until it releases (Fig. 11-4), while carefully holding edge of knife cover and lifting knife cover upward to remove.

NOTE: Slicer will not start with knife cover removed.



Figure 11-3



**BE ALERT.** Slicer knife edge is exposed. Always be aware of the placement of your hands/fingers in relationship to knife.

9. Remove slice deflector. Slice deflector can be removed by loosening screw knobs (Fig. 11-4).

Place all removable parts in a three compartment sink with warm water and a mild detergent solution; soak, clean, and thoroughly scrub all surfaces using a solution of mild detergent and warm water. Removable parts include: food chute and all of its parts, end weight, slide rod, knife cover, knife sharpener and slice deflector



Figure 11-4

Rinse removable parts with fresh, clean water. Following the instructions on your quaternary sanitizer label, soak the food chute and all of its parts, knife cover, knife sharpener and slice deflector in a proper solution of quaternary sanitizer for a minimum of two minutes. Allow these parts to air dry.

**An important step to kill bacteria is to allow the parts to air dry before reinstalling!**

# Cleaning & Sanitizing



**BE ALERT.** The slicer knife is fully exposed. Always be aware of the placement of your hands/fingers in relationship to the knife.

10. Next, clean knife ring guard. Soak a clean cloth in a mild detergent and warm water solution. Ring out excess water from cloth. **Carefully** insert the cloth between knife and knife ring guard (Fig. 12-1). While holding the cloth between knife and knife ring guard, work it along the entire backside of knife. Repeat this procedure as necessary. A nylon brush can also be used, if preferred. Spray sanitizer on all surfaces and let air dry.



Figure 12-1

11. The knife must also be cleaned and sanitized. **Carefully** wash and rinse the top and bottom of knife by wiping from the **center of knife outward** (Fig. 12-2). Spray both sides of knife, slicer table and the entire slicer base with a non-bleach, non-chlorine sanitizer following the instructions on your quaternary sanitizer container to make sure proper sanitation is achieved. Allow slicer parts to air dry.

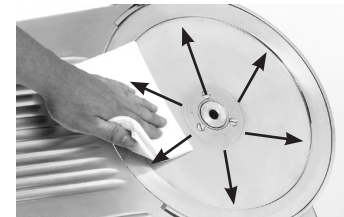

Figure 12-2

**An important step to kill bacteria is to allow the parts to air dry before reassembly!**



**DO NOT allow moisture to get into knife hub.**

After cleaning and sanitizing the knife, the rest of the entire slicer must be fully cleaned, sanitized and left to air dry before reattaching slicer parts and using the slicer.

12. Soak a clean cloth in a mild detergent and warm water solution. Ring out excess water from cloth. With the slicer table completely closed, wipe slicer table off by starting at knife and pulling towards you. Never wipe slicer table towards knife. Spray or wipe a sanitizer on table and allow it to air dry.

13. With a clean cloth soaked in mild detergent, wipe down all remaining surfaces of slicer to remove food, debris and grease/oil. Use a nylon brush to scrub difficult areas. Use a clean, wet cloth to rinse the entire slicer. Finish by spraying sanitizer on all surfaces and then let air dry.

## **REINSTALL REMOVABLE PARTS**

After cleaning, sanitizing, and allowing the parts to air dry, they must be reinstalled.



**BE ALERT.** Slicer knife is exposed. Always be aware of the placement of your hands/fingers in relationship to knife.

1. **Carefully** reinstall slice deflector.
2. Reinstall the knife cover. Place the knife cover over the knife, centering it on the knife hub. Then, while holding the knife cover in place with one hand, begin turning the knife cover release knob clockwise with your other hand until the knife cover is securely into place.

NOTE: The slicer will not start with the knife cover removed.

3. Reinstall knife sharpener. Attach it to the top of slicer and secure it with knife sharpener release knob (Fig 12-4). Note: DO NOT use sharpener with wet stones.



Figure 12-3



**NEVER** operate slicer without knife sharpener. Make sure it is in place and secure to top of slicer before operating.

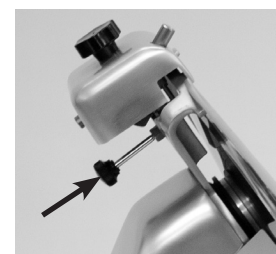

Figure 12-4

# Cleaning & Sanitizing

4. Reassemble food chute.(Fig- 13-1).
5. Place the cleaned and sanitized food chute back onto chute arm. Securely tighten food chute release knob to prevent “play” between food chute and chute arm (Fig. 13-2).
6. Reinstall end weight. Align end weight with chute and insert slide rod through chute and end weight (Fig 13-3). Allow end weight to rest on chute and securely screw in slide rod to slicer chute.
7. Plug in power cord.

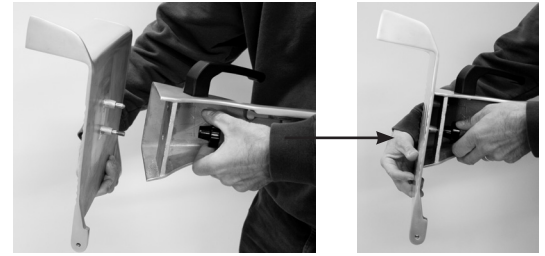

Figure 13-1

## **INSPECTION**

INSPECTING THE SLICER FOR DAMAGED OR BROKEN PARTS INCLUDING GASKETS & SEALS. A thorough visual inspection should be made of the entire slicer and its parts. Globe urges the owner/operator to inspect all components often and for an authorized service agent to inspect the entire slicer at least every 6 months, including all parts that are detachable for cleaning and sanitizing. This inspection should include: looking for damaged parts, broken seals or gaskets, and areas that may be more difficult to clean and sanitize.

## **⚠ WARNING**

IF A SEAL OR GASKET IS FOUND TO NOT PROPERLY SEAL, IS DAMAGED, OR IS MISSING, THE SLICER MUST BE REMOVED FROM SERVICE UNTIL IT IS REPAIRED BY AN AUTHORIZED SERVICER.



Figure 13-2



Figure 13-3

# Knife Sharpening

**WARNING**



## SHARP KNIFE BLADE

### TO AVOID SERIOUS PERSONAL INJURY:

- **NEVER** touch rotating knife.
- **ALWAYS** keep hands clear of all moving parts.
- **ALWAYS** turn slicer off, return the auto engage lever to “Manual” position (G12A only), turn slice thickness dial clockwise until it stops, and remove food chute before sharpening.
- **NEVER** sharpen slicer unless all guards are installed.

### WHEN AND HOW OFTEN TO SHARPEN KNIFE

1. Symptoms of a dull knife are excess waste (or “tail”) on the unsliced portion remaining in food chute.
2. The knife needs to be sharpened periodically to provide consistent slices and maximum food product yield. Sharpening knife lightly every few days is more effective than heavy sharpening at less frequent intervals.

### PREPARING TO SHARPEN



**Make sure auto engage lever is in the “Manual” position (G12A only).**

1. Turn slicer off and turn slice thickness dial clockwise until it stops so slicer table covers knife’s edge.
2. Remove food chute from slicer.
3. Clean and dry both sides of knife before sharpening. Refer to Cleaning & Sanitizing instructions on pages 10 through 13.

NOTE: The knife cover must be on during sharpening. The slicer will not start if knife cover is removed.

4. Loosen sharpener release knob by turning it counterclockwise several times (Fig. 14-1).



**BE ALERT. The next step will expose knife.**

5. Lift sharpener cover up (Fig. 14-1), rotate it clockwise (Fig. 14-2) and lower it into position with knife fitting between the two stones (Fig. 14-3).
6. Tighten sharpener release knob (Fig. 14-1) to secure sharpener.



Figure 14-1



Figure 14-2



Figure 14-3

# Knife Sharpening

## SHARPENING THE KNIFE - (Regular Procedure)

1. Plug in and select the start button on the slicer.
2. Push grinding stone button #2 (Fig. 15-1) and honing stone button #3 (Fig. 15-2) at the same time so both stones make contact with knife. Maintain pressure on the buttons for 5-10 seconds.



**TURN SLICER OFF** before inspecting.

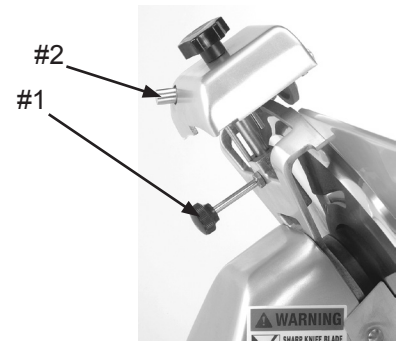

Figure 15-1

## SHARPENING THE KNIFE - (Extended Procedure)

**NOTE:** Use the extended procedure if the regular sharpening procedure does not produce satisfactory results.

1. Start slicer.
2. Push grinding stone button #2 (Fig. 15-1) so the stone sharpens the back side of knife. Maintain pressure on button for 30 seconds.
3. Push grinding stone button #2 (Fig. 15-1) and honing stone button #3 (Fig. 15-2) at the same time so both stones make contact with knife. Maintain pressure on buttons for 5 seconds.

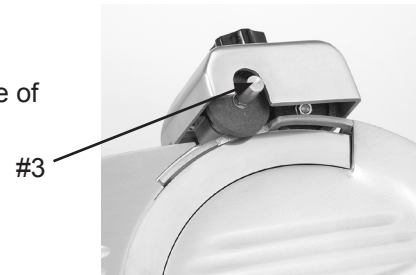

Figure 15-2



**TURN SLICER OFF** before inspecting.

## AFTER SHARPENING

1. Turn slicer off and unplug power cord.
2. Loosen sharpener release knob.
3. Rotate sharpener and place it back in its stored position (Fig. 15-3).
4. Tighten sharpener release knob.
5. **Clean and sanitize** the entire slicer. Refer to Cleaning & Sanitizing on pages 10-13.
6. Reinstall food chute and plug power cord in.



Figure 15-3



**NEVER** operate slicer without knife sharpener. Make sure it is in place and secure to top of slicer before operating.

# Inspections, Simple Maintenance, and Repair

**WARNING**



## SHARP KNIFE BLADE TO AVOID SERIOUS PERSONAL INJURY:

- **BEFORE CLEANING, SHARPENING, SERVICING, OR REMOVING ANY PARTS** always turn off and unplug slicer, turn slice thickness dial clockwise past zero “0” until it stops, and remove food chute.
- **NEVER TOUCH KNIFE.** Keep hands and arms away from all moving parts.
- **DO NOT** tamper with, bypass or remove any safety devices, guards, START/STOP button or touch pad controls.
- **AFTER EACH USE, ALWAYS** turn slicer off, return auto engage lever to “Manual” position (automatic slicers only) and turn the slice thickness dial clockwise past zero “0” until it stops.
- **USE ONLY GLOBE PARTS AND ACCESSORIES** properly installed.

### INSPECTING THE SLICER

INSPECTING THE SLICER FOR DAMAGED OR BROKEN PARTS INCLUDING GASKETS & SEALS. A thorough visual inspection should be made of the entire slicer and its parts. Globe urges the owner/operator to inspect all components often and for an authorized service agent to inspect the entire slicer at least every 6 months, including all parts that are detachable for cleaning and sanitizing. This inspection should include looking for damaged parts, broken seals or gaskets, and areas that may be more difficult to clean and sanitize.

**WARNING**

IF A SEAL OR GASKET IS FOUND TO NOT PROPERLY SEAL, IS DAMAGED OR IS MISSING, THE SLICER MUST BE REMOVED FROM SERVICE UNTIL IT IS REPAIRED BY AN AUTHORIZED SERVICER.

### SLICER INSPECTION

Slicer Seals and Gaskets Identified



I  
N  
S  
P  
E  
C  
T





# Inspections, Simple Maintenance, and Repair

## LUBRICATION

Various slicer parts need to be lubricated periodically using Globe oil. Globe oil is a light, tasteless, odorless mineral oil that will not contaminate or impart odors or taste to sliced food products.

**CAUTION** DO NOT USE VEGETABLE OIL TO LUBRICATE SLICER. VEGETABLE OIL WILL DAMAGE THE SLICER!

### Food Chute Slide Rod

It is necessary to lubricate food chute slide rod with Globe oil if food chute becomes difficult to push.

1. Make sure slicer is off and unplugged. Then remove food chute.
2. Tilt slicer on its end. NOTE: The bottom of the G12A is completely covered. Unscrew four rubber feet to remove slicer cover.
3. Put several drops of Globe oil on slide rod (Fig. 17-1) towards top of rod.
4. Tilt slicer back to its normal position.
5. Push food chute back and forth several times to distribute oil onto slide rod.
6. Reinstall food chute.
7. Plug slicer in.

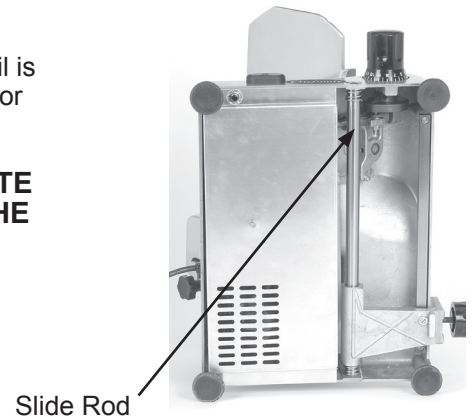

Figure 17-1

### Sharpener Shafts

It is necessary to lubricate the sharpener shafts with Globe oil every week.

1. Loosen sharpener release knob and pull sharpener up to remove it (Fig. 17-2).
2. Put several drops of Globe oil on shaft behind each sharpening stone (Fig 17-3).
3. Push both sharpener buttons a couple of times to distribute oil onto shafts.
4. Put several drops of Globe oil on main shaft (Fig. 17-2), place sharpener back into position and tighten sharpener release knob.
5. Wipe off any excess oil that drips onto slicer.

NOTE: The sharpener and stones can be cleaned with warm water and a brush. Allow it to air dry. **If the sharpener or stones are cleaned, it is very important that all sharpener shafts are lubricated with Globe oil afterwards!**

### End Weight Slide Rod

The end weight slide rod should be lubricated with a few drops of Globe oil, every week or when excessive drag is felt.

1. Apply a few drops of Globe oil to slide rod (Fig. 17-4).
2. Slide end weight up and down to distribute oil.

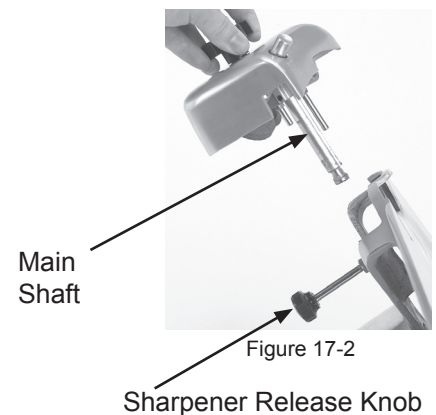

Figure 17-2

Sharpener Release Knob

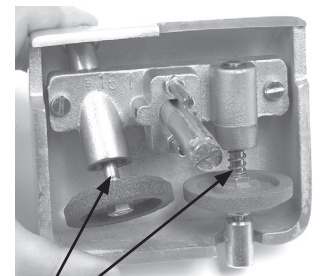

Figure 17-3

Shafts



Figure 17-4

# Troubleshooting Guide

PROBLEM	CAUSE	SOLUTION
Slicer will not start	Slicer not plugged in	Plug in slicer
	Knife cover removed or not properly installed	Install knife cover and tighten the knife cover release knob
	Motor reset button tripped	Press the reset button located underneath the slicer
Ragged cuts-poor yield	Dull knife	Sharpen knife-make sure knife and stones are clean
	Chipped knife	Sharpen or have new knife installed
	Knife-slicer table gap too wide	Call for service to adjust slicer table
	Knife too small	Have new knife installed
Metal rubbing knife	Knife cover	Tighten knife cover release knob
	Food chute	Tighten or adjust food chute knob
	End weight	Have defective end weight replaced
	Slicer table	Call for service to adjust slicer table
Hard to push food chute	No lubrication	Lubricate slide rods thoroughly with Globe oil. <b>Do not use vegetable oil!</b>
Hard to sharpen	Stones dirty, wet or clogged with grease	Clean stones with warm water and a brush. Allow stones to air dry. Lubricate shafts with Globe oil afterwards.
	Knife dirty	Clean top and bottom of knife
	Worn stones	Have stones replaced
	Stones not properly aligned	Have sharpener adjusted
Slicer stops running	Motor overheated	Wait 10-15 minutes for slicer to cool down. Push the reset button, then start the slicer.

If problems persist and the assigned solution does not remedy the issue, please call our Service Department at 866-260-0522.



## Limited Slicer Warranty

Globe Food Equipment Company (“GFE”) warrants to the original purchaser of new equipment that said equipment, when installed in accordance with our instructions within North America and subjected to normal use, is free from defects in material or workmanship for a period of 1 year from installation or 18 months from actual shipment date, whichever date occurs first.

THIS WARRANTY IS IN LIEU OF ALL OTHER WARRANTIES, WHETHER EXPRESSED OR IMPLIED. GFE EXPRESSLY DISCLAIMS ANY IMPLIED WARRANTY OF MERCHANTABILITY OR EXPRESSED OR IMPLIED WARRANTY OF FITNESS FOR A PARTICULAR PURPOSE.

GFE’S OBLIGATION AND LIABILITY UNDER THIS WARRANTY IS EXPRESSLY LIMITED TO REPAIRING AND REPLACING EQUIPMENT WHICH PROVES TO BE DEFECTIVE IN MATERIAL OR WORKMANSHIP WITHIN THE APPLICABLE WARRANTY PERIOD. All repairs pursuant to this Warranty will be performed by an Authorized Designated GFE Service Location during normal working hours. IN NO EVENT SHALL GFE BE LIABLE FOR INCIDENTAL OR CONSEQUENTIAL DAMAGES TO BUYER OR ANY THIRD PARTY, INCLUDING, WITHOUT LIMITATION, LOSS OF PROPERTY, PERSONAL INJURY, LOSS OF BUSINESS OR PROFITS OR OTHER ECONOMIC LOSSES, OR STATUTORY OR EXEMPLARY DAMAGES, WHETHER IN NEGLIGENCE, WARRANTY, STRICT LIABILITY OR OTHERWISE.

This warranty is given only to the first purchaser from a retail dealer. No warranty is given to subsequent transferees.

This warranty does not cover product failures caused by: failure to maintain, neglect, abuse, damage due to excess water, fire, normal wear, improper set up and use. Periodic maintenance including lubrication and sharpening are not covered.

This Warranty is not in force until such time as a properly completed, digitally signed, and the Installation/Warranty Registration has been received by GFE within 30 days from the date of installation. Complete warranty registration at: [www.globefoodequip.com/support/warranty-registration-form](http://www.globefoodequip.com/support/warranty-registration-form).

THE FOREGOING WARRANTY PROVISIONS ARE A COMPLETE AND EXCLUSIVE STATEMENT BETWEEN THE BUYER AND SELLER. GFE NEITHER ASSUMES NOR AUTHORIZES ANY PERSONS TO ASSUME FOR IT ANY OTHER OBLIGATION OR LIABILITY IN CONNECTION WITH SAID EQUIPMENT.

Example of items not covered under warranty, but not limited to just these items:

1. Acts of God, fire, water damage, burglary, accident, theft, vandalism.
2. Freight damage.
3. Improper installation or alteration of equipment.
4. Use of generic or after market parts.
5. Repairs made by anyone other than a GFE designated servicer.
6. Lubrication.
7. Expendable wear parts, knife, stones, rubber boots, blown fuses, lamps.
8. Cleaning of equipment.
9. Misuse or abuse.

WARRANTY REGISTRATION  
SCAN THE QR CODE WITH YOUR MOBILE DEVICE OR GO TO  
[WWW.GLOBEFOODEQUIP.COM](http://WWW.GLOBEFOODEQUIP.COM)  
TO FILL OUT AND SUBMIT YOUR WARRANTY REGISTRATION.

[WWW.GLOBEFOODEQUIP.COM/SUPPORT/WARRANTY-REGISTRATION-FORM](http://WWW.GLOBEFOODEQUIP.COM/SUPPORT/WARRANTY-REGISTRATION-FORM)

