



Outperform every day.™

Project:  
Item Number:  
Quantity:

Sous Vide Immersion Circulator

The Vollrath Company, L.L.C.

# SOUS VIDE IMMERSION CIRCULATOR



40868



40861

## ITEMS

- 40868 Immersion Circulator (head only)
- 40861 Immersion Circulator (head, bath and cover)

## FEATURES

- Stainless steel housing for durability
- Temperature stability to 0.1°F (0.06°C) for precise results
- Maximum temperature is 200°F (93°C)
- Two pump speeds for flexible cooking
- Three convenient programmable settings
- LED display is easy to read
- Celsius or Fahrenheit temperature readouts for precise cooking
- 40861 includes a convenient factory fitted drain valve for easy cleaning
- 6 ft. (1.8m) cord and plug

**Note:** When using Vollrath circulating head 40868 tank capacity must not exceed 7.9 gallons (30L)

## DESCRIPTION

The Vollrath Sous Vide Thermal Immersion Circulator is available as a complete cooking unit with a water bath and cover; or as just a Thermal Immersion Circulator head. The Sous Vide Thermal Immersion Circulator complements Vollrath's In-Chamber and Out-of-Chamber Vacuum Pack machines and Cayenne® Charbroilers to provide a complete Sous Vide prep and cooking solution.

### Agency Listings

#### Circulator Head



#### Water Bath and Cover



## WARRANTY

All models shown come with Vollrath's standard warranty against defects in materials and workmanship. For full warranty details, please refer to [www.Vollrath.com](http://www.Vollrath.com).

Due to continued product improvement, please consult [www.vollrath.com](http://www.vollrath.com) for current product specifications.

| Approvals | Date |
|-----------|------|
|           |      |



Outperform every day.™

[www.vollrath.com](http://www.vollrath.com)

### The Vollrath Company, L.L.C.

1236 North 18th Street  
Sheboygan, WI 53081-3201 U.S.A.  
Main Tel: 800.624.2051 or 920.457.4851  
Main Fax: 800.752.5620 or 920.459.6573  
Customer Service: 800.628.0830  
Canada Customer Service: 800.695.8560

Technical Services  
[techservicereps@vollrathco.com](mailto:techservicereps@vollrathco.com)  
Induction Products: 800.825.6036  
Countertop Warming Products: 800.354.1970  
All Other Products: 800.628.0832

# SOUS VIDE IMMERSION CIRCULATOR

## DIMENSIONS (Shown in inches (cm))

**40868**

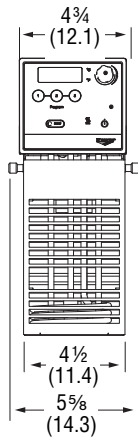

Front View

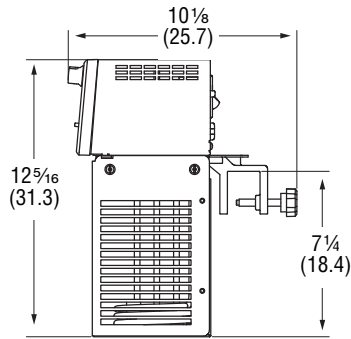

Side View

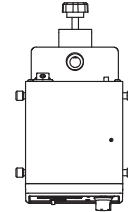

Top View

**40861**

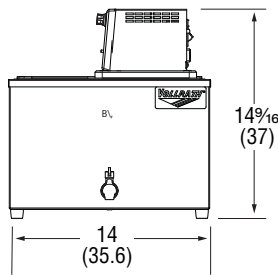

Front View

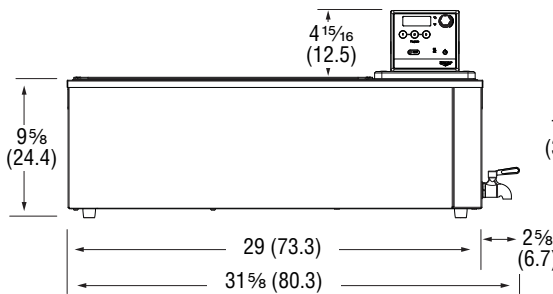

Side View

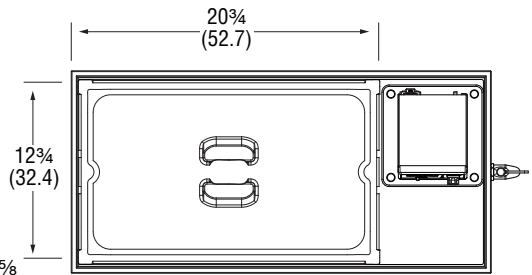

Top View

## SPECIFICATIONS

| Item No. | Description                                    | Voltage | Watts | Amps | Plug          | Shipping Container<br>W x D x H          | Weight<br>LB (Kg) |
|----------|--|---------|-------|------|---------------|--|-------------------|
| 40868    | Immersion Circulator<br>(head only)            | 120V    | 1100  | 11   | NEMA<br>5-15P | 12 x 8 x 15 1/2<br>(30.5 x 20.3 x 39.4)  | 10 1/2<br>(4.8)   |
| 40861    | Immersion Circulator<br>(head, bath and cover) |         |       |      | NEMA<br>5-15P | 19 x 34 x 14 1/2<br>(48.3 x 86.4 x 36.8) | 49<br>(22,2)      |

### Receptacle

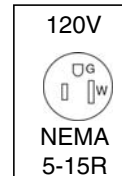

Outperform every day.™

[www.vollrath.com](http://www.vollrath.com)

### The Vollrath Company, L.L.C.

1236 North 18th Street  
Sheboygan, WI 53081-3201 U.S.A.  
Main Tel: 800.624.2051 or 920.457.4851  
Main Fax: 800.752.5620 or 920.459.6573  
Customer Service: 800.628.0830  
Canada Customer Service: 800.695.8560

Technical Services  
techservicereps@vollrathco.com  
Induction Products: 800.825.6036  
Countertop Warming Products: 800.354.1970  
All Other Products: 800.628.0832