



Project:
Item Number:
Quantity:

20 AND 26 INCH CHEESE MELTERS (MODELS JW1, JW2)



JW1



JW2

DESCRIPTION

Vollrath's 20 and 26 Inch Cheese Melters are ideal for melting cheese on nachos, cheese fries or soup; finishing potato skins and garlic bread; or warming plates. The compact cheese melters are well-suited for medium-volume food service operations. They are not intended for continuous use.

AGENCY LISTINGS



Due to continued product improvement, please consult www.vollrath.com for current product specifications.

ITEMS

Item No.	Model No.	Description
CM2-12020	JW1	20" Cheese Melter, 120V
CM2-12026	JW2	26" Cheese Melter, 120V

FEATURES

- Stainless steel construction.
- Energy efficient, fast reacting quartz heaters.
- 15-minute timer.
- Standby mode saves 50% during off-peak times.
- 5 shelf positions.
- 120V, plug in nearly anywhere.
- 4 ft. (1.2 m) cord with plug.
- Made in the USA.

WARRANTY

- Warrantied parts: The warranty period is 2 year parts, 1 year labor.
- Heater tubes: The warranty period is 1 year, including labor when performed at an authorized service center. Heater tube glass damage is not covered by this warranty.
- For full warranty details, please refer to www.Vollrath.com.

CLEARANCE AND ENVIRONMENT REQUIREMENTS

- Do not place on surfaces or near walls, partitions or kitchen furniture unless they are made of non-combustible material or clad with non-combustible heat-insulating material. Cheese melters must not be used near or below curtains and other combustible materials.
- Allow a minimum of 8" (20.3 cm) of clearance on the left and right sides of the cheese melter.
- Maximum ambient temperature: 104° F (40 ° C).

Approvals	Date



www.vollrath.com

The Vollrath Company, L.L.C.

1236 North 18th Street
 Sheboygan, WI 53081-3201 U.S.A.
 Main Tel: 800.624.2051 or 920.457.4851
 Main Fax: 800.752.5620 or 920.459.6573
 Customer Service: 800.628.0830
 Canada Customer Service: 800.695.8560

Technical Services
techservicereps@vollrathco.com
 Toaster Products: 800.309.2250
 All Other Products: 800.628.0832

20 AND 26 INCH CHEESE MELTERS (MODELS JW1, JW2)

DIMENSIONS (Shown in inches (cm))

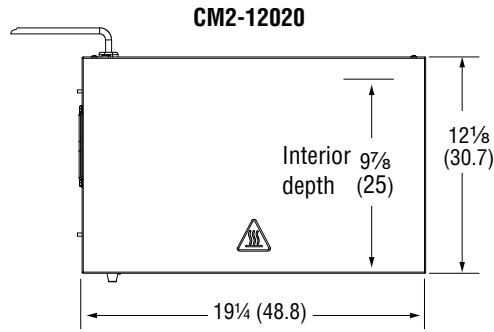

Top View

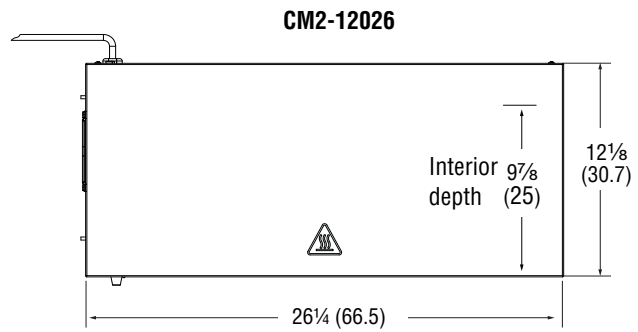

Top View

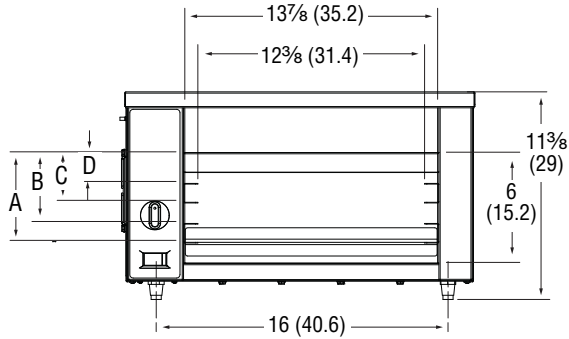

Front View

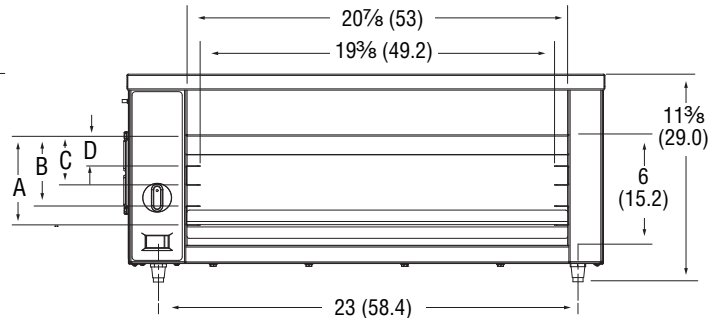

Front View

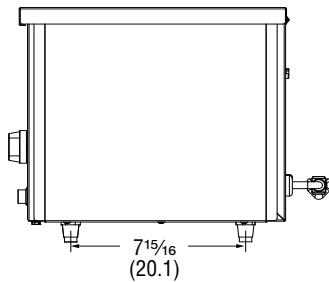

Side View

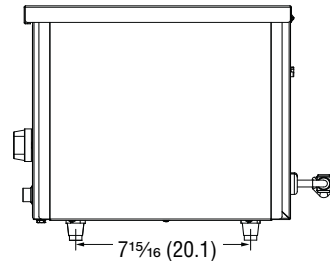

Side View

SPECIFICATIONS

Item No.	Model	Shelf Clearance				Phase	Voltage	Watts	Amps	Hz	Weight LB (KG)	Plug
		A	B	C	D							
CM2-12020	JW1	$4\frac{7}{8}$ (12.4)	$3\frac{3}{4}$ (9.5)	$2\frac{1}{16}$ (6.8)	$1\frac{1}{16}$ (3.4)	1	120	1200	10	60	20 (9.1)	NEMA 5-15
CM2-12026	JW2							1650	13.8		36 (16.3)	

Receptacle

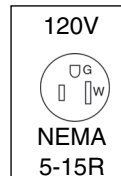

www.vollrath.com

The Vollrath Company, L.L.C.

1236 North 18th Street
 Sheboygan, WI 53081-3201 U.S.A.
 Main Tel: 800.624.2051 or 920.457.4851
 Main Fax: 800.752.5620 or 920.459.6573
 Customer Service: 800.628.0830
 Canada Customer Service: 800.695.8560

Technical Services
techservicereps@vollrathco.com
 Toaster Products: 800.309.2250
 All Other Products: 800.628.0832