

1.9L Thermal Carafe Blk (1pk)

Height: 7.1" Width: 6.6" Depth: 8.6"
(18.0cm) (16.8cm) (21.8cm)

- Holds 64oz (1.9L) of coffee or other hot beverages
- Unbreakable stainless steel interior and exterior
- Vacuum insulation keeps beverages hot for hours



Agency:



Specifications

Product #: 40163.0000

Finish: Stainless/Black

Liner: Stainless Steel

Lid Color: Black

Additional Features

Holding Capacity

English	Metric
-	-



BUNN® reserves the right to change specifications and product design without notice. Such revisions do not entitle the buyer to corresponding changes, improvements, additions or replacements for previously purchased equipment. For most current specifications and other info visit bunn.com.

Last Updated:
04/08/2021

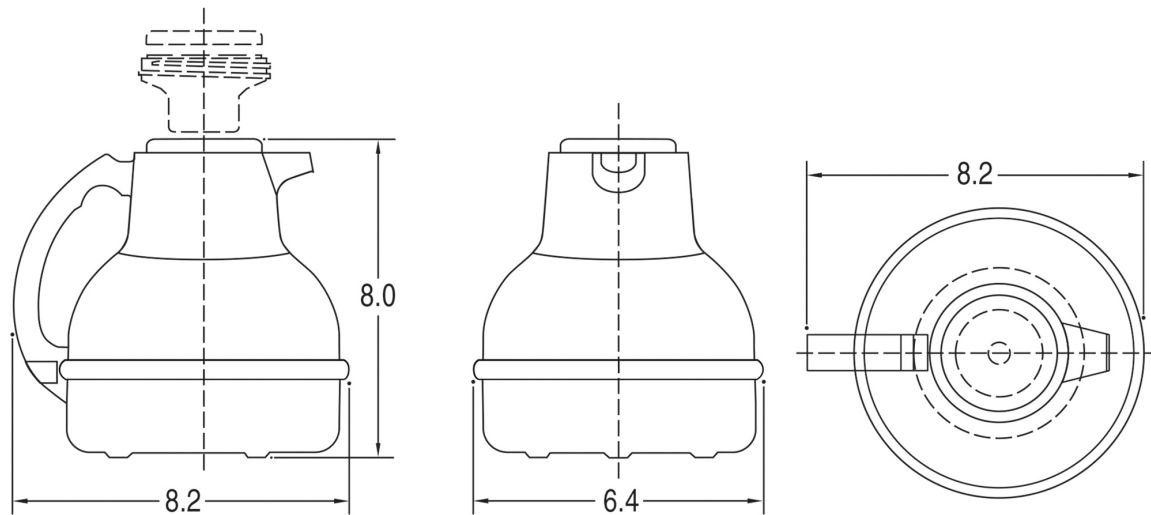

1.9 litre Deluxe Thermal Carafe

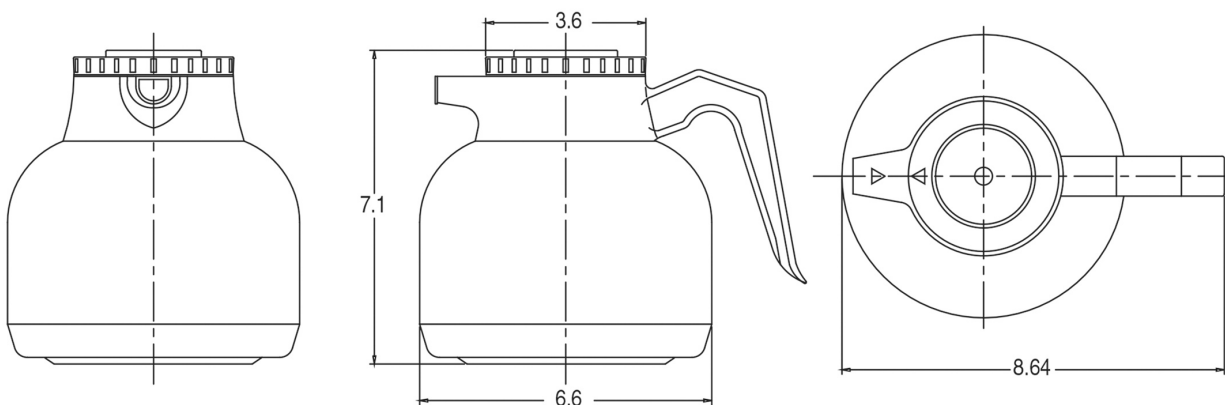

1.9 litre Economy Thermal Carafe

	Unit			Shipping				
	Height	Width	Depth	Height	Width	Depth	Weight	Volume
English	7.1 in.	6.6 in.	8.6 in.	8.3 in.	7.5 in.	7.0 in.	2.350 lbs	0.252 ft ³
Metric	18.0 cm	16.8 cm	21.8 cm	21.1 cm	19.1 cm	17.8 cm	1.066 kgs	0.007 m ³



BUNN® reserves the right to change specifications and product design without notice. Such revisions do not entitle the buyer to corresponding changes, improvements, additions or replacements for previously purchased equipment. For most current specifications and other info visit bunn.com.

Last Updated:
04/08/2021

Related Products & Accessories: 1.9L Thermal Carafe Blk (1pk)(40163.0000)

LID, CARAFE 1.9L-BLK

Product #: 40162.0000



BUNN® reserves the right to change specifications and product design without notice. Such revisions do not entitle the buyer to corresponding changes, improvements, additions or replacements for previously purchased equipment. For most current specifications and other info visit bunn.com.

Last Updated:
04/08/2021

Model Compatibility: 1.9L Thermal Carafe Blk (1pk)(40163.0000)

Serving and Holding selections are currently unavailable. Please contact your sales representative to find out more information.



BUNN® reserves the right to change specifications and product design without notice. Such revisions do not entitle the buyer to corresponding changes, improvements, additions or replacements for previously purchased equipment. For most current specifications and other info visit bunn.com.

Last Updated:
04/08/2021